

7'x14' UTILITY VAULT

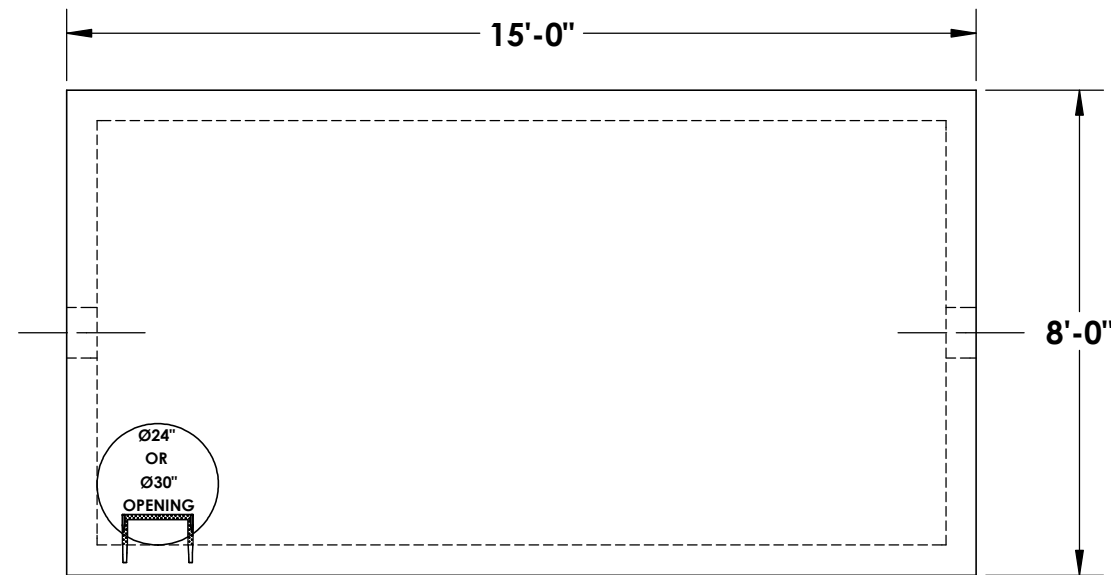

~ COVER
7,565# (1.87 CU/YDS)

~ SECTION
9,745# (2.41 CU/YDS)

~ BASE
9,645# (2.38 CU/YDS)

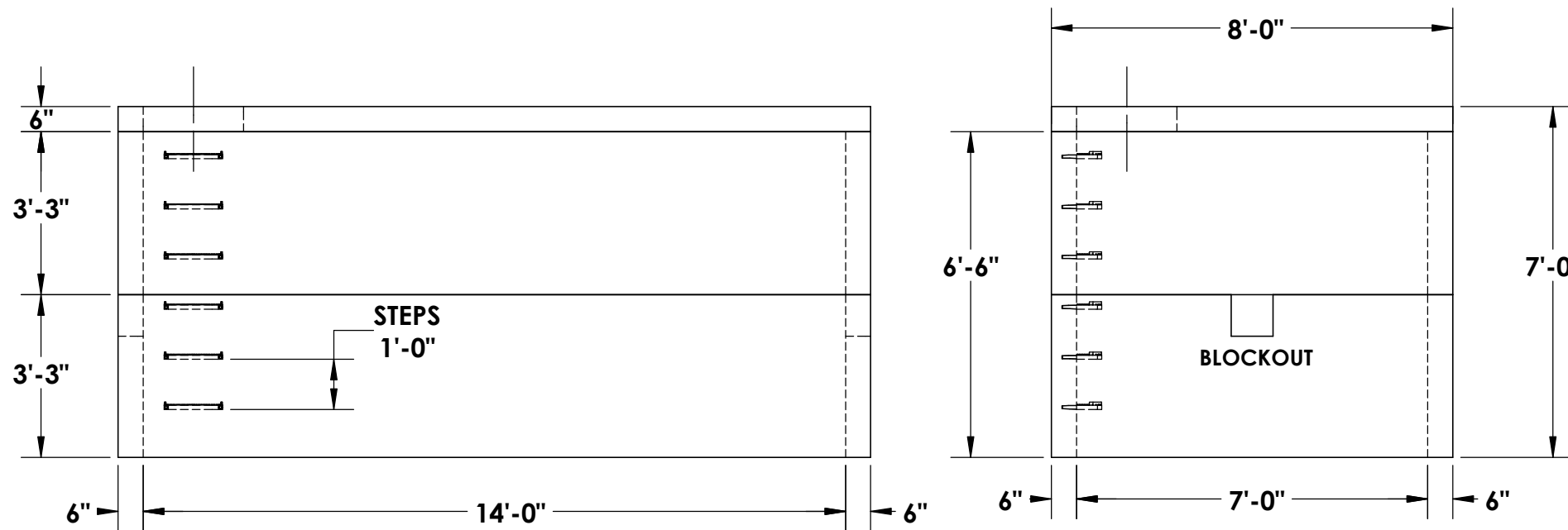
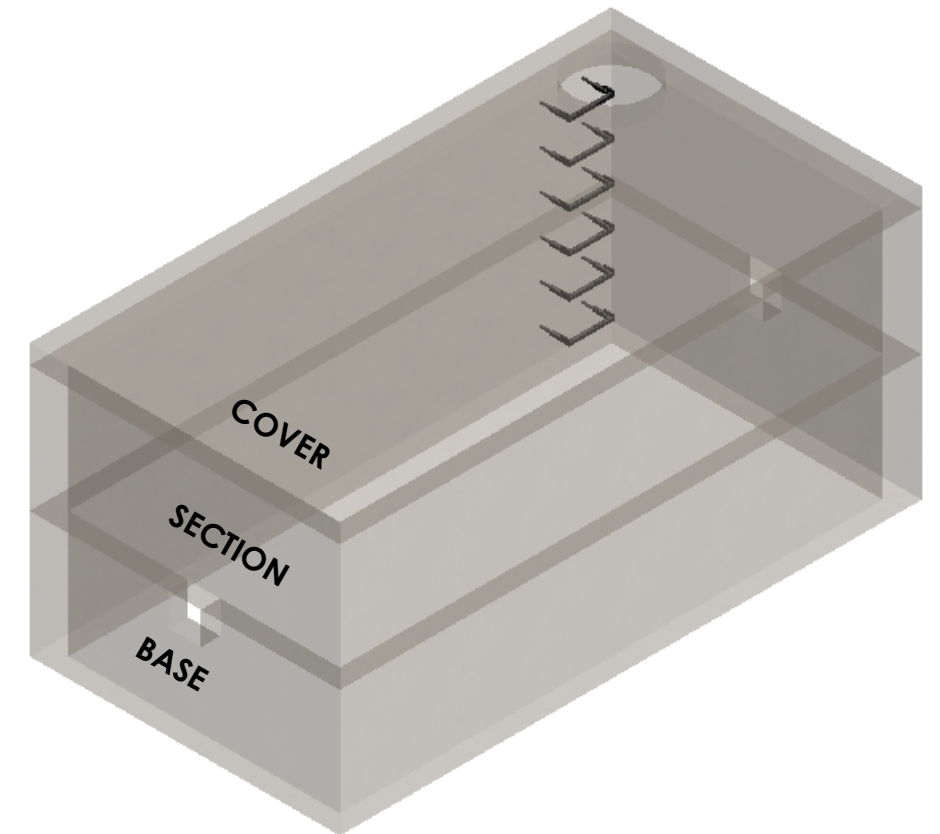

CONCRETE:
4,000 PSI MINIMUM

REINFORCEMENT:
#4 BAR @ 12" O.C.E.W. THROUGHOUT

BLOCKOUT:
SIZES AVAILABLE UPON REQUEST

***TRAFFIC RATED (8" THICK) COVER AVAILABLE**

© INLAND NORTHWEST PRECAST



INLAND NORTH WEST PRECAST

5516 NORTH STARR RD PO BOX 610, NEWMAN LAKE, WA 99025 (509) 226-5050



ALL UTILITY VAULTS MEET AND ARE
CONSTRUCTED IN ACCORDANCE
WITH ASTM C858