

4'x6' UTILITY VAULT

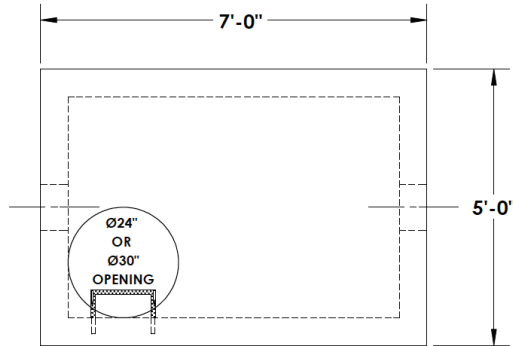

~ COVER
2,390# (0.59 CU/YDS)

~ SECTION
5,360# (1.32 CU/YDS)

~ BASE
5,260# (1.30 CU/YDS)

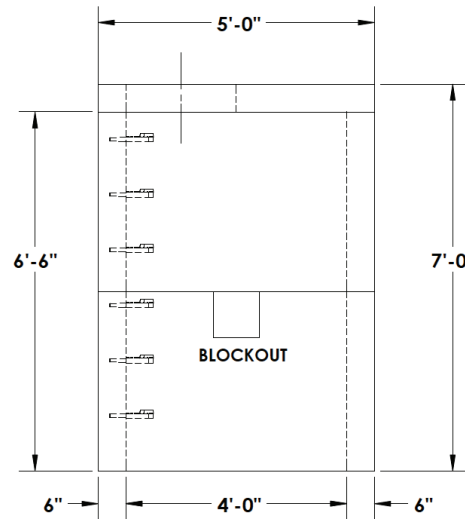
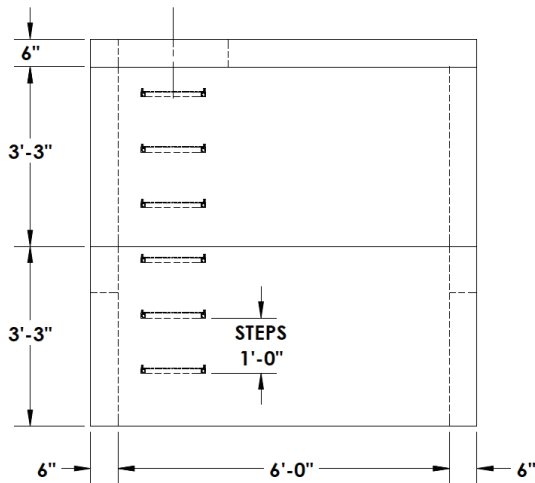
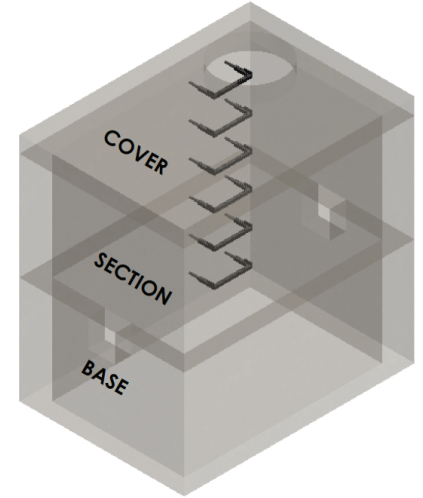

CONCRETE:
4,000 PSI MINIMUM

REINFORCEMENT:
#4 BAR @ 12" O.C.E.W. THROUGHOUT

BLOCKOUT:
SIZES AVAILABLE UPON REQUEST

***COVER AVAILABLE IN TRAFFIC RATED (8" THICK)**

© INLAND NORTHWEST PRECAST



INLAND NORTH WEST PRECAST

5516 NORTH STARR RD PO BOX 610, NEWMAN LAKE, WA 99025 (509) 226-5050



ALL UTILITY VAULTS MEET AND ARE CONSTRUCTED IN ACCORDANCE WITH ASTM C858