

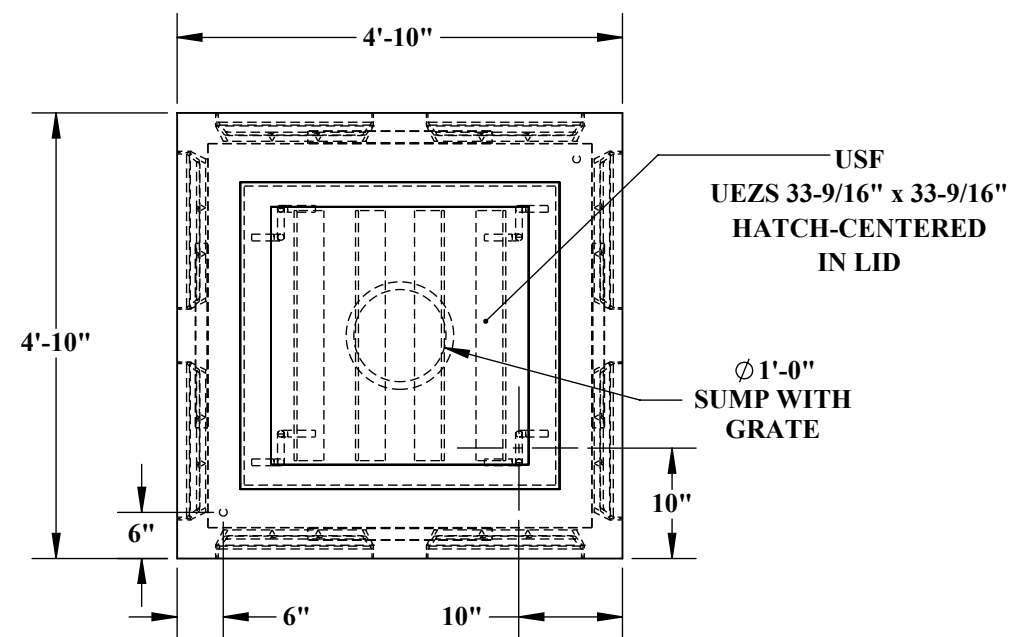

ELECTRICAL VAULT SMALL 4'-0" x 4'-0" x 4'-6"



~WEIGHT

- LID - 775# (0.19 CU/YDS)

-BASE/WALL - 4,525# (1.17 CU/YDS)

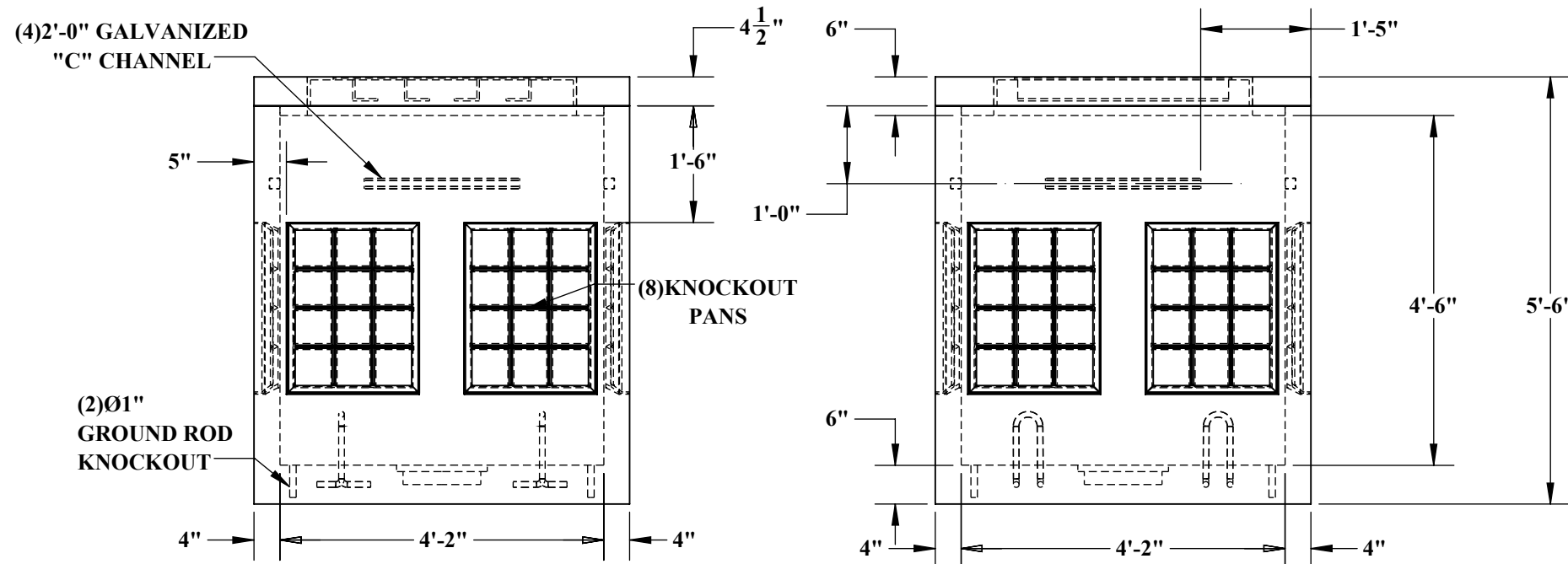
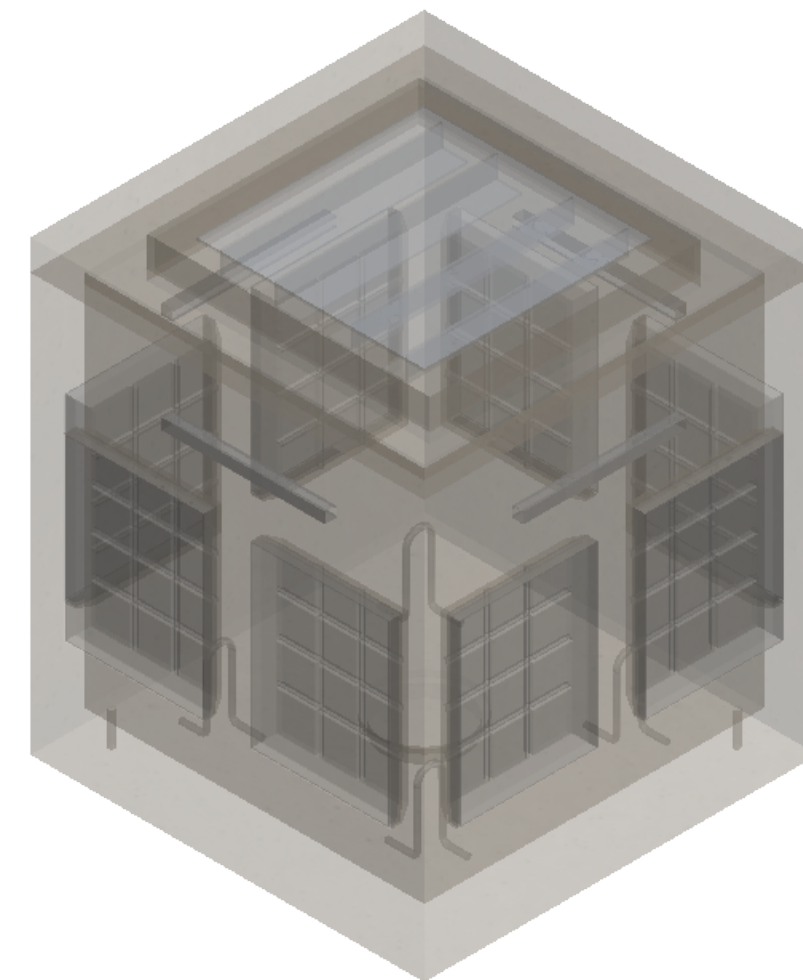

*ALL VAULTS MEET AND ARE CONSTRUCTED IN ACCORDANCE WITH ASTM C858



5204 NORTH STARR RD PO BOX 610
NEWMAN LAKE, WA 99025
(509) 226-5050
www.inwprecast.com

VAULT SCHEDULE:



PROJECT:

CONTRACTOR:

DATE: